

Cambridge Brass
P.O. Box 249
140 Orion Place
Cambridge, Ontario
Canada N1R 5V1
Tel: (519) 621-5520
Fax: (519) 621-8674
http://www.cambridgebrass.com

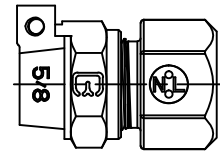

ADAPTER STYLE



MODEL NO. 117NL

CAMPAK x
FEMALE COPPER FLARE

117NL-B2P2/117NL-B3P2/117NL-B4P5

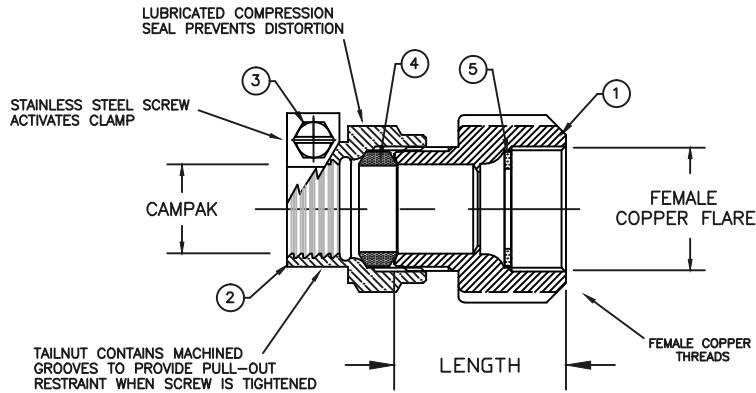

PARTS AND MATERIAL:

1. BODY: CAST BRASS, ALLOY C89833
2. COMPRESSEION NUT: CAST BRASS, ALLOY C83600
3. SCREW: STAINLESS STEEL, ALLOY 304
4. COMPRESSION SEAL: NITRILE RUBBER
5. SEALING WASHER: COPPER

FEATURES:

- CONFORMS TO AWWA C800 (ASTM B584 UNS C89833 FOR ALL BRASS PARTS IN CONTACT WITH POTABLE WATER)
- CONFORMS TO ANSI/NSF 61-8
- CONFORMS TO ANSI/NSF 372 (COMPLIANT WITH US Safe Drinking Water Act. PL 111-380)
- BODY AND NUTS PROVIDE WRENCH FLATS FOR INSTALLATION
- 300PSI WORKING PRESSURE

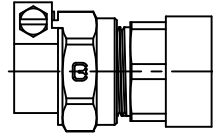

117NL-B3P3

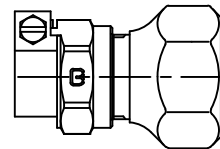

117NL-B3P4

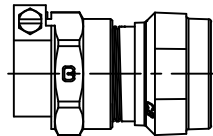

117NL-B4P4

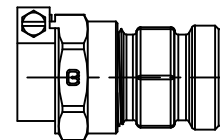

117NL-B4P3

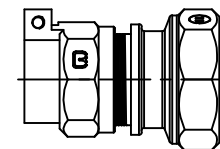

117NL-B6P6/117NL-B7P7

Cambridge Brass considers the information in this submittal form to be correct at the time of publication. Item and option availability, including specifications, are subject to change without notice.

CATALOG NO.	CAMPAK	FEMALE COPPER FLARE	LENGTH	APPROX. WT. LBS.
117NL-B2P2	5/8"	5/8"	1.47"	0.69
117NL-B3P2	3/4"	5/8"	1.61"	0.73
117NL-B3P3	3/4"	3/4"	1.79"	0.73
117NL-B3P4	3/4"	1"	2.00"	0.90
117NL-B4P3	1"	3/4"	2.29"	1.23
117NL-B4P4	1"	1"	2.03"	1.30
117NL-B4P5	1"	1 1/4"	2.26"	1.35
117NL-B6P6	1 1/2"	1 1/2"	2.79"	3.50
117NL-B7P7	2"	2"	3.19"	4.50

Submitted by: